



Unit 7-9 Youngs Industrial Estate,
 Stanbridge Road,
 Leighton Buzzard,
 Bedfordshire,
 LU7 4QB
 Tel: 01525 373 202
 Fax: 01525 373 222
 www.onthelevel.co.uk
 sales@onthelevel.co.uk
 technical@onthelevel.co.uk

Product Code

LAFORM12/8

Drawing Specification

Product Description
 24mm Former 1200mm x 800mm with integrated gradient.

Purpose
 The OTL Level Access Former once installed is concealed - they cannot be seen. The purpose of a former is to provide a sufficient gradient in the floor within the showering zone. The former provides the perfect solution in order for water to quickly drain directly towards a gully outlet.

Where
 Easy Access Accessible bathrooms. Safe showering environments.

Most Commonly Used In
 Private homes, Care homes, Hospitals, Holiday homes, Schools, Gyms, Local Authority Grants.

All Level Access formers can be trimmed onsite if required.

Used only in conjunction with Non slip vinyl sheet flooring

Vertical waste option also available.

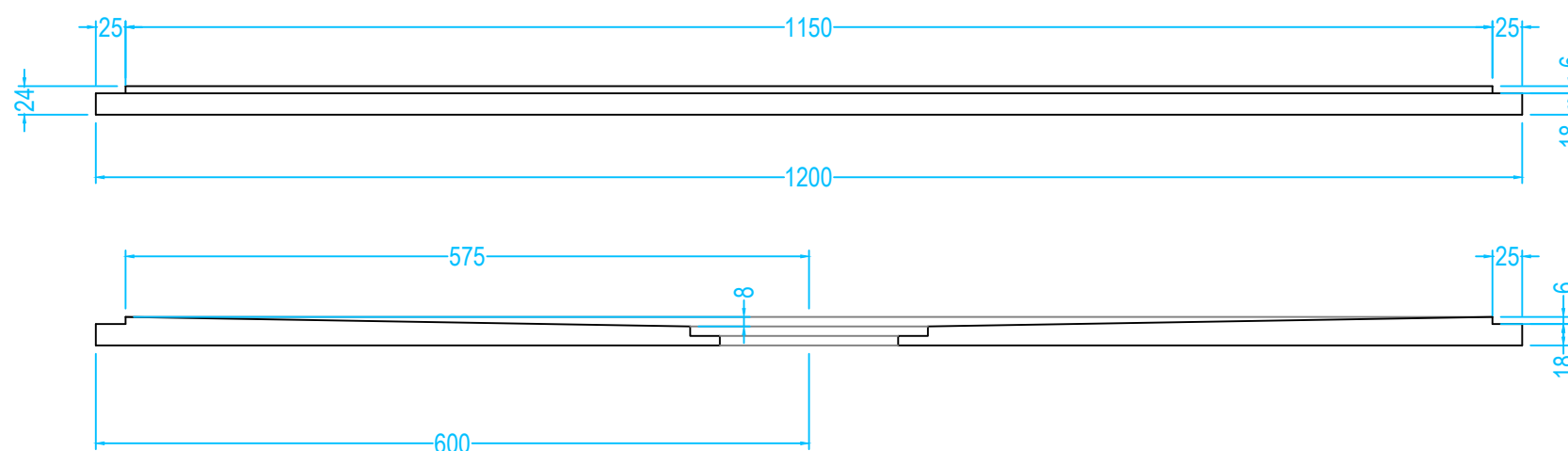
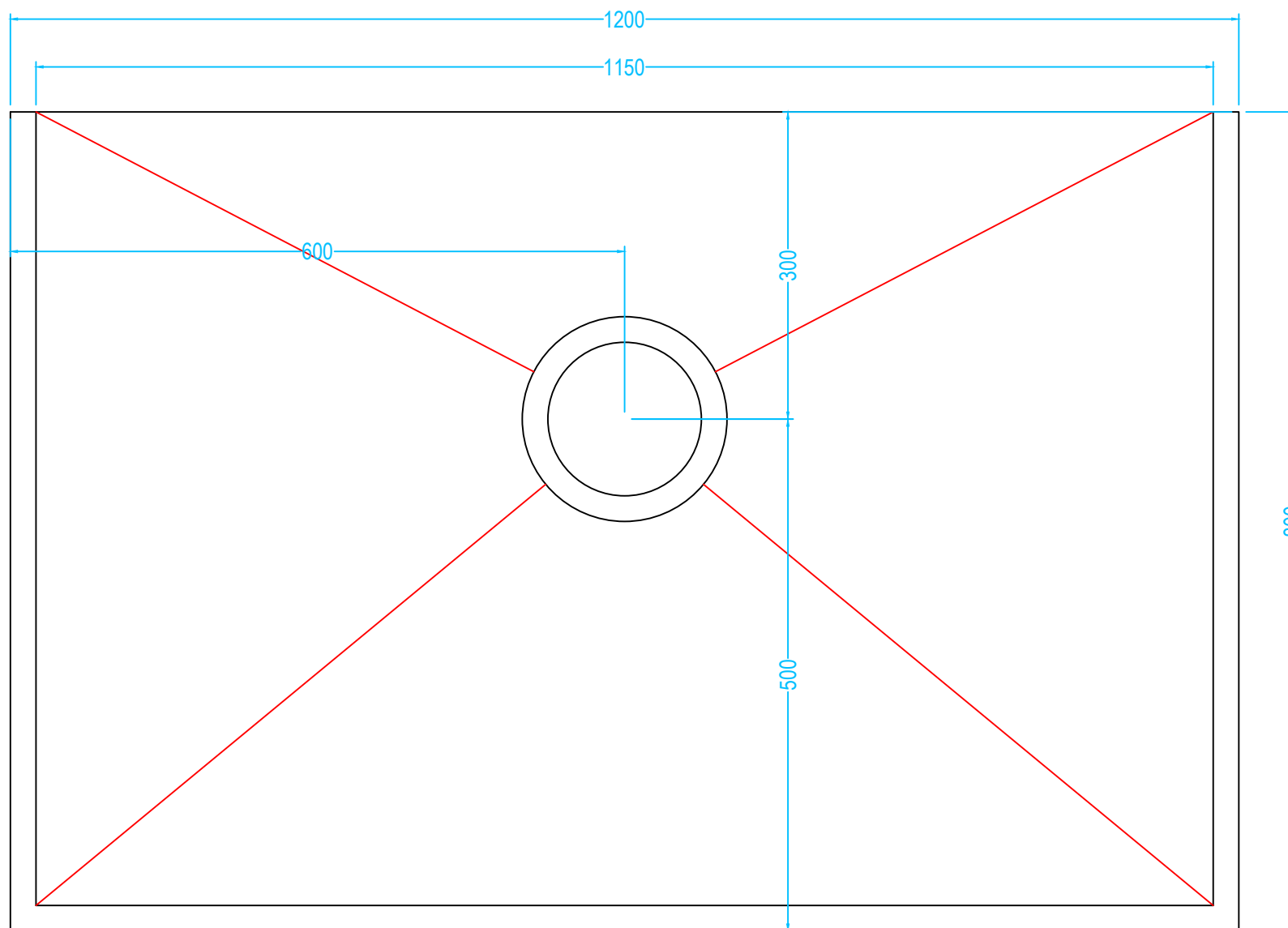

All OTL Level Access Formers are supplied with a vertical or horizontal outlet

